

CMT ORANGE TOOLS®

3D Router Carver System

CABINET DOOR AND PANEL CARVINGS

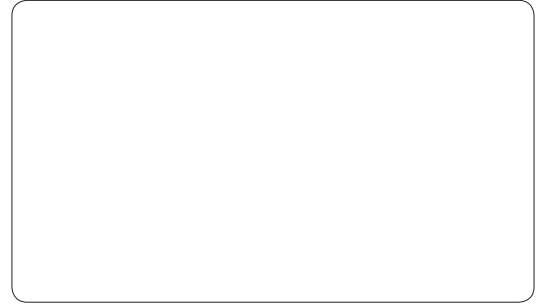

C.M.T. UTENSILI S.p.A.
Via della Meccanica
61122 Pesaro_Italia
Tel. #39 0721 48571
Fax #39 0721 481021
info@cmtorangetools.com
www.cmtorangetools.com

CMT USA, Inc.
7609 Bentley Road Suite D
Greensboro, NC 27409
phone 336.854.0201
fax 336.854.0903
info@cmtusa.com
www.cmtorangetools.com

Includes templates for one of these designs:

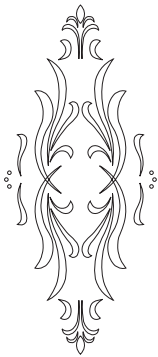

Classical
RCS-302

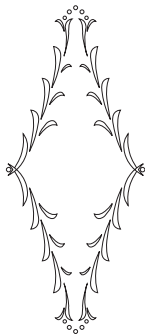

Florentine
RCS-304

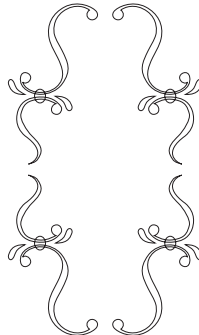

Cascade
RCS-305

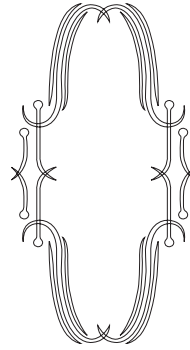

Roma
RCS-306

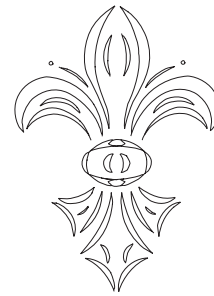

Fleur-de-Lys
RCS-805

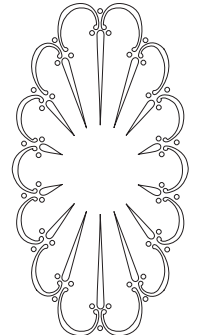

Spanish Fan
RCS-806

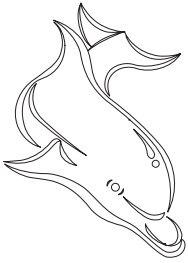

Dolphin
RCS-803

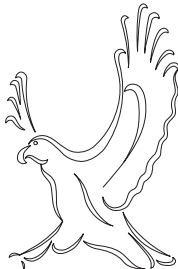

Eagle
RCS-804



Deer
RCS-901



Horse
RCS-902



Longhorn
RCS-904

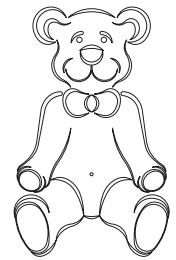

Teddy Bear
RCS-906

Please see label below for design in this package.

Please refer to back for instructions. Use these templates with Holding Frame #**RCS-003**



WARNING: Drilling, sawing, sanding or machining wood products can expose you to wood dust, a substance known to the State of California to cause cancer. Avoid inhaling wood dust or use a dust mask or other safeguards for personal protection. For more information go to www.P65Warnings.ca.gov/wood **WARNING:** This product can expose you to formaldehyde, which is known to the State of California to cause cancer. For more information go to www.P65Warnings.ca.gov



BE CAREFUL!
USE GLOVES.

Made in Italy
Insert #RCS-INS01

BIT AND ROUTER SET UP

1. The 3D Router Carver bit includes a round set up jig (see the dotted line in Fig. 1). Adjust the bit so that the cutting edge is flush with this jig. This ensures that the routed grooves will be the correct depth. Adjust by loosening the locking nut and turning the cutter in or out as required. (In extremely hard wood it may be necessary to set the bit for a shallow first cut and then set to normal position for the finish cut.) The set up jig simulates the thickness of the templates and ensures that the cutting tip is just touching the workpiece to begin the carving.
2. Tighten the 3D Router Carver bit into your router collet and release the plunge mechanism, allowing smooth travel of the router along the plunge guides. Keep the router's plunge guides well-lubricated.

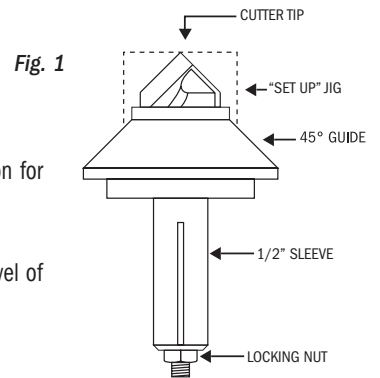

FRAME AND TEMPLATE SET UP

3. Select the required design templates and corresponding holding frame. Secure the holding frame to the workpiece by clamping or tacking (see Fig. 2).
4. Insert one template into the holding frame (there may be up to 4 templates per design). The templates are designed to fit tightly into the frame, and therefore NO separate clamping is required. (see Fig. 3)

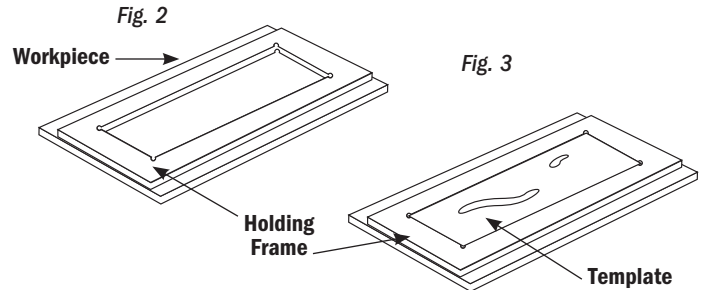

ROUTING TECHNIQUE

5. Start the router and position over the widest part of a slot. Plunge down until the cone shaped guide comes into contact with both edges of the slot, then move to the end of the slot. By plunging down at the widest part of the slot, the risk of the cutting edge coming into contact and damaging the template is reduced.
 6. Make one pass through the entire length of the slot. This removes the bulk of the material. Follow up with a finishing pass. Repeat for all slots in the template.
- Note:** keep a slight downward pressure on the machine as it moves along the slot. The depth and width of the cut will be automatically controlled by the combination of the template and the cone shaped guide.
7. Once all cuts on the first side of the template have been completed, remove and realign the template as indicated in the following section.

TEMPLATE ORIENTATION

Very important: depending on the shape of the carving design, some templates will be routed more than one time. To determine the proper method for your design, refer to the label on the template package. The label will indicate that the design is either **"Two-Way Symmetrical,"** or **"Four-Way Symmetrical,"**. Next, refer to the proper carving technique below.

Note: many of the instructions below require you to flip or rotate templates. If a slot is located in such a way that it will duplicate a slot routed in a previous step, you do not need to rout it again.

TWO-WAY SYMMETRICAL DESIGN (Fig 4)

1. Notice the "T" engraved in the templates indicating the top of the design.
2. Rout the design, then flip the template over, keeping the "T" at the top.
3. Repeat entire procedure for all templates in this design.

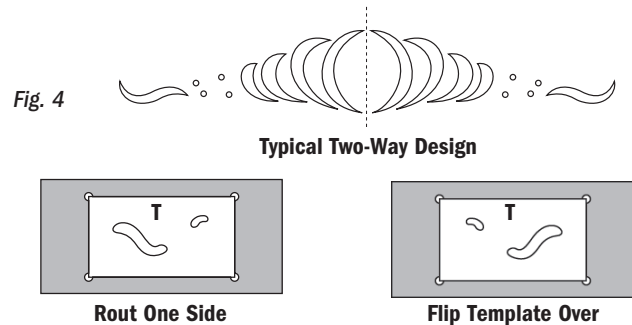

CORNER DESIGN TEMPLATES (Fig. 5)

1. Rout all slots in one side of the template. (note that there is no top or bottom to these designs).
2. Rotate template 180° and rout all slots again.
3. Flip the template over and rout again.
4. Rotate 180° and rout again (all slots should be routed a total of 4 times)
5. Repeat procedure for all templates in this design.

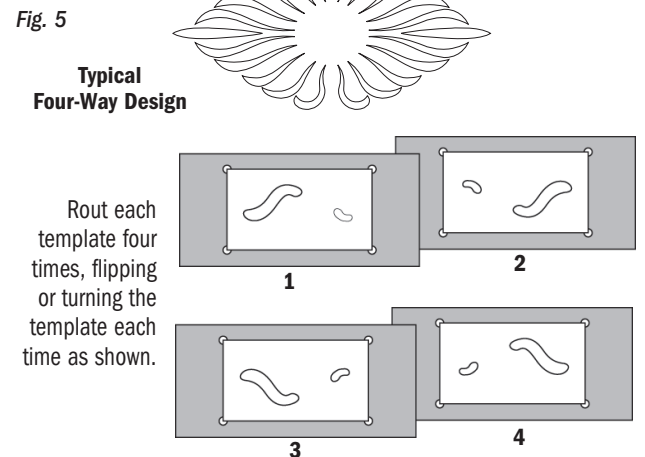

NOTES:

1. All templates and frames are manufactured within acceptable tolerances. However, it is possible that there may be some slight movements of the template within the holding frame.
2. Slight variations to the illustrated design drawings may occur.
3. A MYRIAD OF DESIGN VARIATIONS ARE POSSIBLE by simply excluding "unwanted" cuts. It is not necessary to use all the slots of a particular template. This results in a wide range of more open-less complicated designs.